



Thule XT Kit 3070

> Instructions

- CITROËN Nemo**, 3-dr Van, 08-
- CITROËN Nemo**, 4-dr Van, 08-
- CITROËN Nemo**, 5-dr Van, 08-
- FIAT Fiorino**, 3-dr Van, 08-
- FIAT Fiorino**, 4-dr Van, 08-
- FIAT Fiorino**, 5-dr Van, 08-
- FIAT Qubo**, 4-dr MPV, 08-
- FIAT Qubo**, 5-dr MPV, 08-
- PEUGEOT Bipper**, 3-dr Van, 08-
- PEUGEOT Bipper**, 4-dr Van, 08-
- PEUGEOT Bipper**, 5-dr Van, 08-

This kit is only for vehicles with fixpoint mounting.

ISO 11154-E

183070

C.20130612
509-3070-01

Bring your life
thule.com

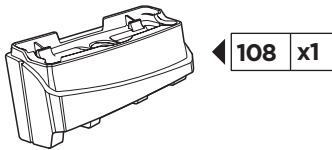
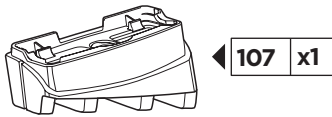
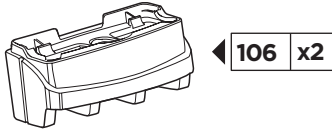
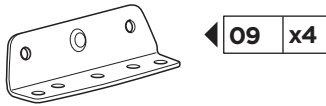

50985

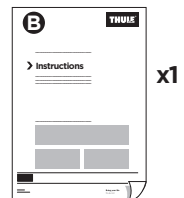
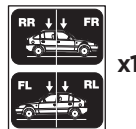
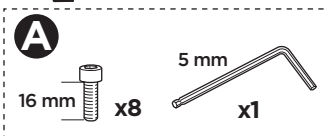
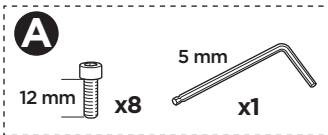
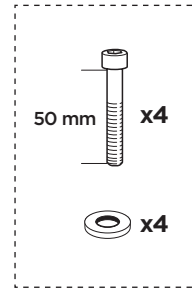

1

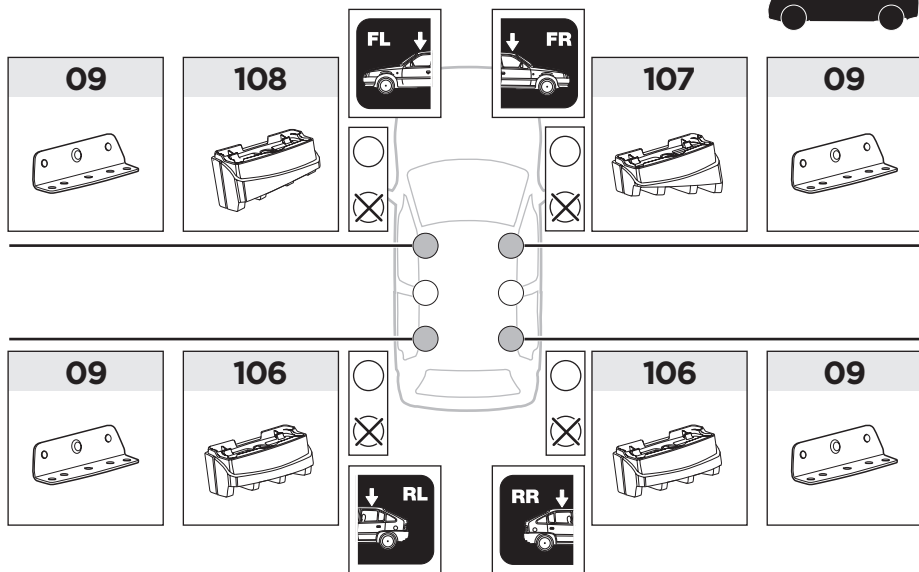
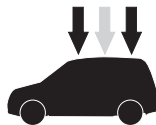
751
FootPack

A

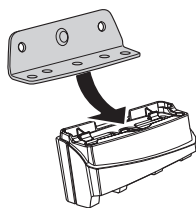

B

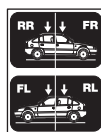
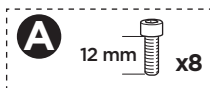

x1

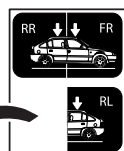

EN Only a few turns
DE Nur wenige Umdrehungen
FR Quelques tours uniquement
NL Slechts enkele slagen
IT Solo qualche giro
ES Sólo algunas vueltas
PT Noções básicas
SV Endast några varv
DK Kun nogle få omgange
NE Bare noen få omdreinger
FI Vain muutama kierros

ET Ainult mõni pööre
LV Tikai dažī apgriezieni
LT Tik keli pasukimai
PL Wystarczy kilka obrotów
RU Только несколько оборотов
UK Лише декілька обертів
BG Само няколко завъртания
CS Pouze několik otáček
SK Len niekoľko otáčok
SL Le nekaj obratov
HR/BIH Samo nekoliko okreta

RO Doar câteva rotiri
HU Csak néhány fordítás
EL Μόνο λίγες περιστροφές
TR Yalnızca birkaç tur

بعض دورات فقط **AR**
 רק מספר סיבובים **HE**

ZH 仅几圈
JA 2～3回転のみ
KO 몇 번만 돌리면 됨
TH เพียงสองสามรอบ

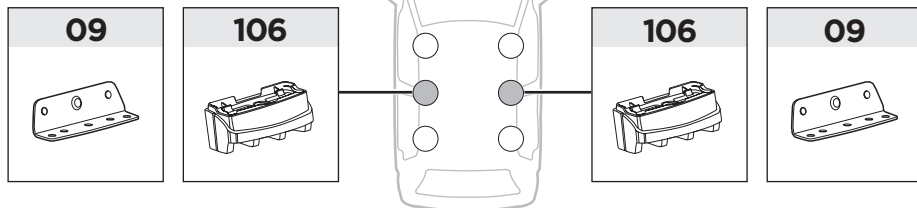
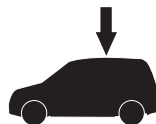
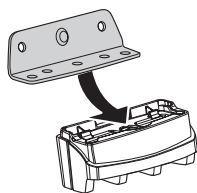
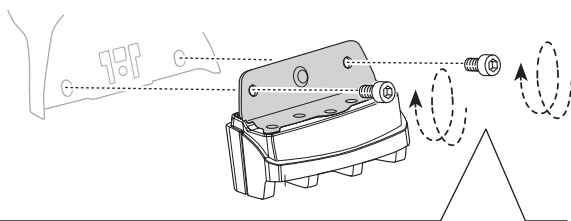
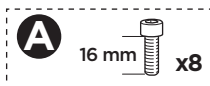
1**753**
FootPack**A****B**

| | | |
|-------------------------------------|-------------------------------------|----------------------------------|
| EN Only a few turns | ET Ainult mõni pööre | RO Doar câteva rotiri |
| DE Nur wenige Umdrehungen | LV Tikai dažī apgriezieni | HU Csak néhány fordítás |
| FR Quelques tours uniquement | LT Tik keli pasukimai | EL Μόνο λίγες περιστροφές |
| NL Slechts enkele slagen | PL Wystarczy kilka obrotów | TR Yalnızca birkaç tur |
| IT Solo qualche giro | RU Только несколько оборотов | AR بعض دورات فقط |
| ES Sólo algunas vueltas | UK Лише декілька обертів | HE רק מספר סיבובים |
| PT Noções básicas | BG Само няколко завъртания | ZH 仅几圈 |
| SV Endast några varv | CS Pouze několik otáček | JA 2～3回転のみ |
| DK Kun nogle få omgange | SK Len niekoľko otáčok | KO 몇 번만 돌리면 됨 |
| NE Bare noen få omdreinger | SL Le nekaj obratov | TH เพียงสองสามรอบ |
| FI Vain muutama kierros | HR/BIH Samo nekoliko okreta | |

2



751
FootPack

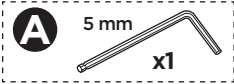
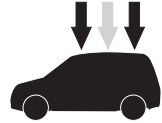
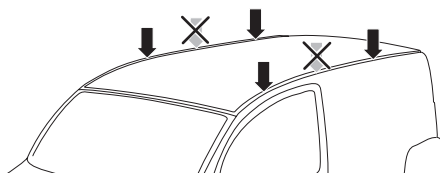

A

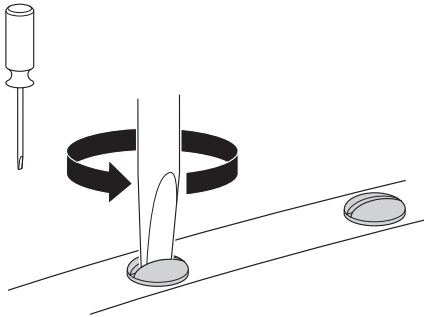

B

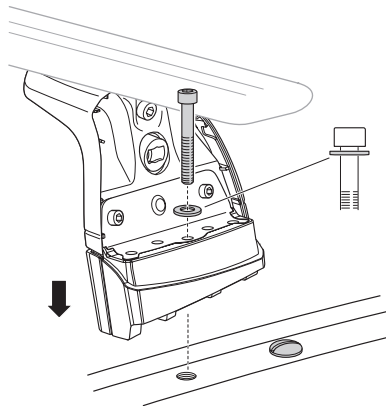

C

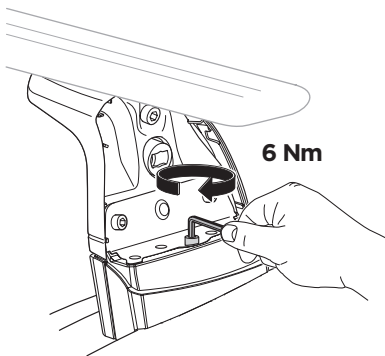

D

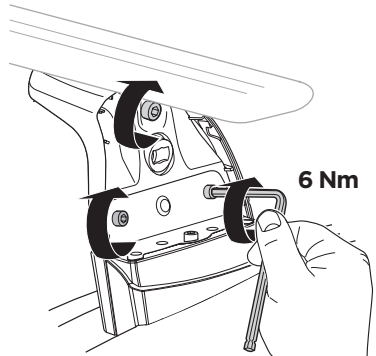

2

753
FootPack

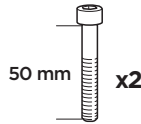
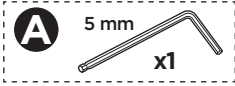
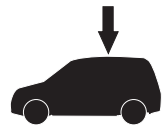
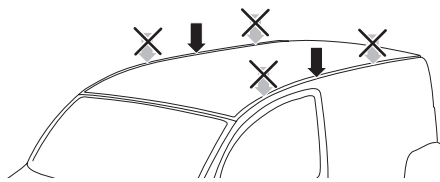

A

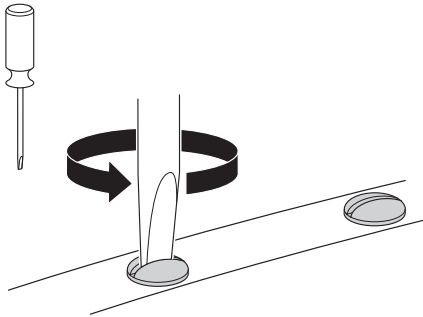

B

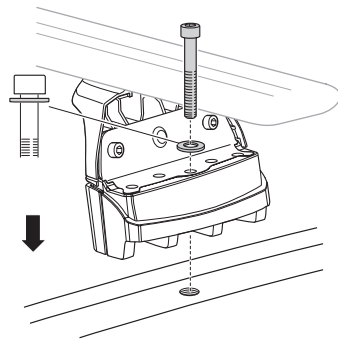

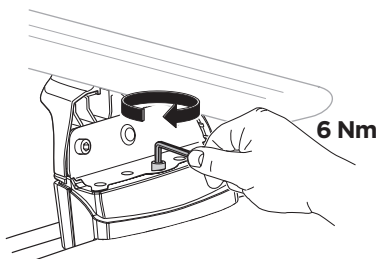

C

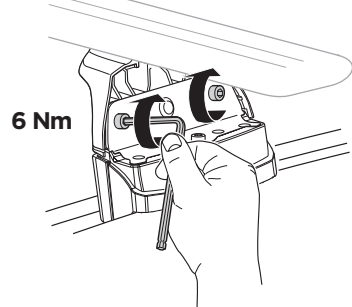

D



WW ▶  Thule Sweden AB, Box 69, 330 33 Hillerstorp, SWEDEN
NA ▶  Thule Inc., 42 Silvermine Road, Seymour, Connecticut 06483, USA

 info@thule.com
 Phone: 800-238-2388

 www.thule.com

› PART OF THULE GROUP

509-3070-01