

1

Kit 5063

FORD Ranger, 4-dr Double Cab, 11-
 FORD Ranger, 4-dr Super Cab, 11-
 MAZDA BT-50, 4-dr Double Cab, 12-
 MAZDA BT-50, 2-dr Single Cab, 12-



ISO 11154-E

1 KIT

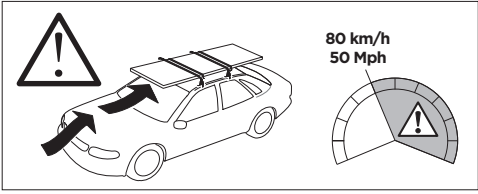
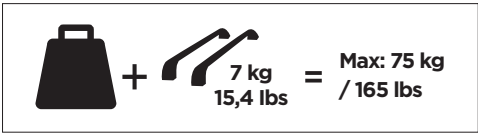
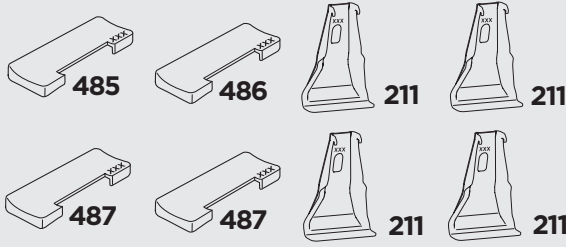
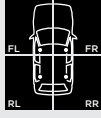
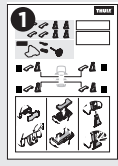

2 FOOT PACK

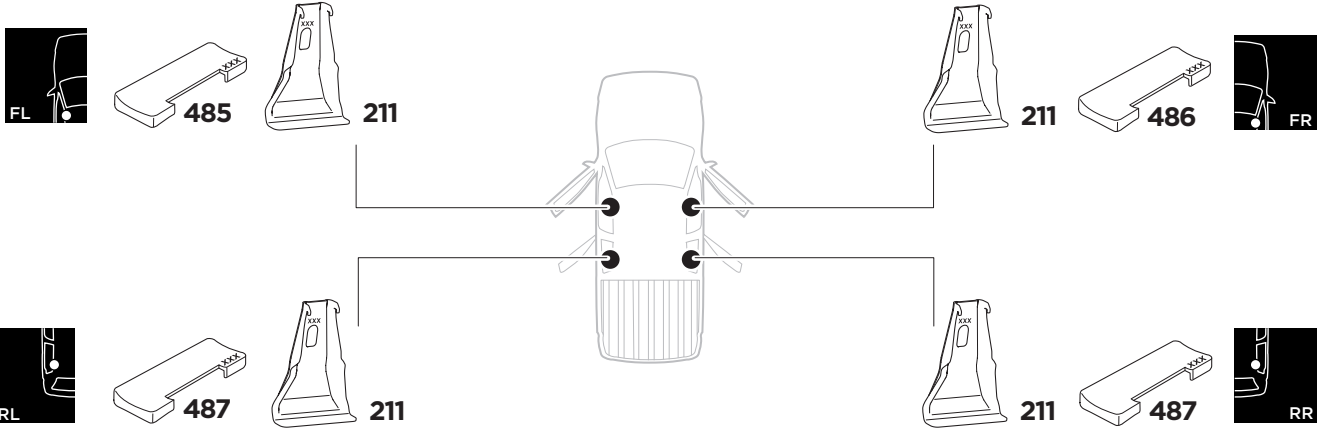
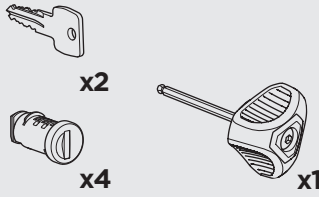
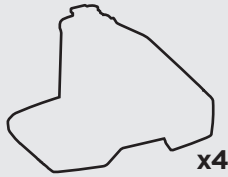
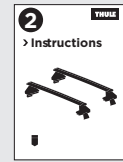

1





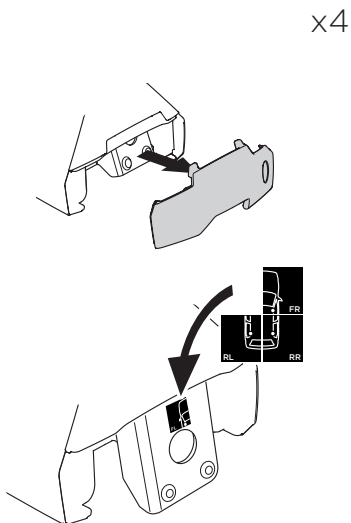

2

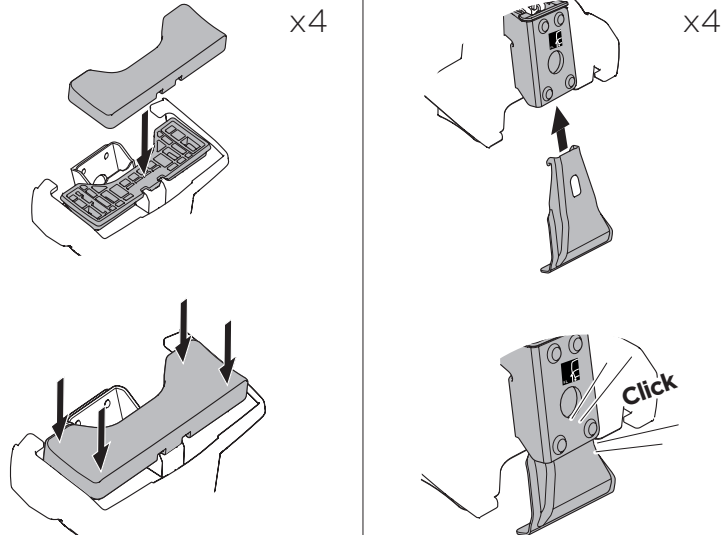

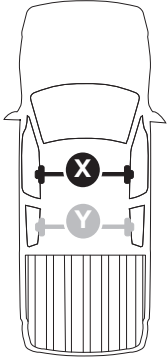

3









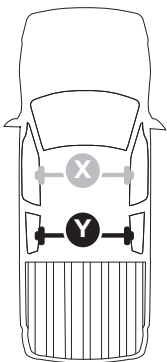

 THULE WingBar Evo  THULE WingBar Edge  THULE WingBar  THULE SquareBar	Evo X (scale)	Edge X (scale)
FORD Ranger , 4-dr Double Cab, 11-	47	C
FORD Ranger , 4-dr Super Cab, 11-	47	C
MAZDA BT-50 , 4-dr Double Cab Cab, 12-	47	C
MAZDA BT-50 , 2-dr Single Cab Cab, 12-	47	C

 THULE ProBar  THULE SlideBar	X (mm/inch)
FORD Ranger , 4-dr Double Cab, 11-	1121 mm / 44 1/8"
FORD Ranger , 4-dr Super Cab, 11-	1121 mm / 44 1/8"
MAZDA BT-50 , 4-dr Double Cab, 12-	1121 mm / 44 1/8"
MAZDA BT-50 , 2-dr Single Cab, 12-	1121 mm / 44 1/8"



 THULE WingBar Evo  THULE WingBar Edge  THULE WingBar  THULE SquareBar	Evo Y (scale)	Edge Y (scale)
FORD Ranger , 4-dr Double Cab, 11-	44,5	H
FORD Ranger , 4-dr Super Cab, 11-	44,5	H
MAZDA BT-50 , 4-dr Double Cab, 12-	44,5	H
MAZDA BT-50 , 2-dr Single Cab, 12-	-	-

 THULE ProBar  THULE SlideBar	Y (mm/inch)
FORD Ranger , 4-dr Double Cab, 11-	1096 mm / 43 1/8"
FORD Ranger , 4-dr Super Cab, 11-	1096 mm / 43 1/8"
MAZDA BT-50 , 4-dr Double Cab, 12-	1096 mm / 43 1/8"
MAZDA BT-50 , 2-dr Single Cab, 12-	-

	W (mm/inch)	Z (mm/inch)
FORD Ranger , 4-dr Double Cab, 11-	600 mm / 23 5/8"	185 mm / 7 1/4"
FORD Ranger , 4-dr Super Cab, 11-	600 mm / 23 5/8"	185 mm / 7 1/4"
MAZDA BT-50 , 4-dr Double Cab, 12-	600 mm / 23 5/8"	185 mm / 7 1/4"
MAZDA BT-50 , 2-dr Single Cab, 12-	-	185 mm / 7 1/4"

